

# MANDÍK<sup>®</sup>

## LONG-REACH NOZZLE

### DDME

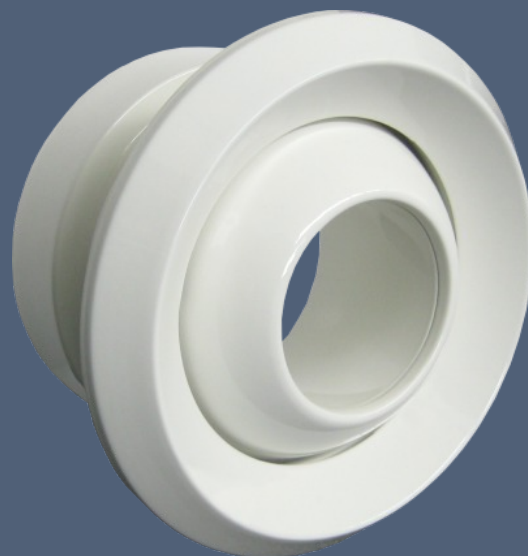

These technical specifications state a row of manufactured sizes and models of long-reach nozzles (further only nozzles) DDME.  
It is valid for production, designing, ordering, delivery, assembly and operation.

Description.....	3
Material and Design.....	3
Assembly and Installation.....	3
Operating Conditions.....	3
Order key.....	3
Dimensions.....	4
Weights.....	4
Technical data.....	4
Logistics terms.....	9

## Description

The nozzles as an end air-conditioning element are designed for the distribution of supply air over long distances. The direction of the supply air flow is influenced by the temperature difference between the supply air and the air in the room, as well as by external influences such as the local air flow. To ensure the optimum air distribution in the heating, ventilation, and cooling modes, the output direction of the supply air has to be changed. The direction of the air flowing out from the nozzle can be adjusted manually. The adjustment can be done by 30° in all directions.



## Material and Design

The nozzles are made of aluminium and powder coated in RAL9010 (gloss).

## Assembly and Installation

The nozzle can be wall-mounted or installed in round or square pipes. The nozzle is equipped with a cover ring to hide the mounting screws. To remove the cover, rotate it by a quarter turn.

## Operating Conditions

The temperature of the flowing air must be between -20 °C and +70 °C. The nozzles are designed for a weather-protected environment with the climate classification class 3K5, without condensation, icing, ice formation and without water also from sources other than rain, in accordance with EN 60721-3-3 amendment A2. The nozzles are designed for air masses without any abrasive, chemical, and sticky additives.

## Order key

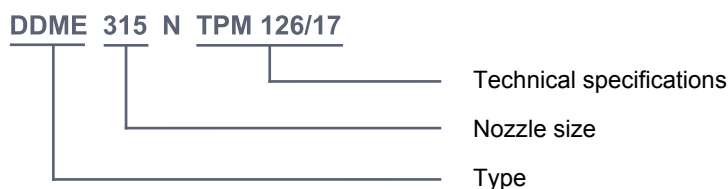

**Dimensions**

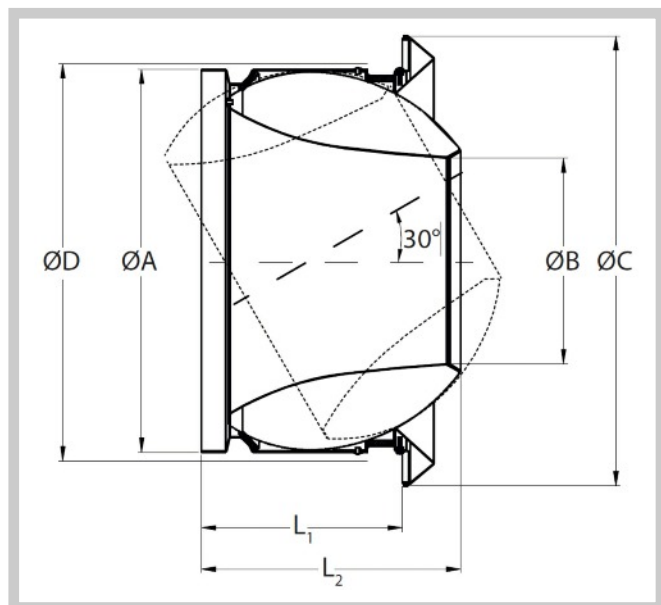

Dimension	øA [mm]	øB [mm]	øC [mm]	øD [mm]	L1 [mm]	L2 [mm]
125	123	60	175	130	72	100
160	158	80	210	165	90	120
200	198	105	266	205	109	143
250	248	128	315	255	135	180
315	313	165	395	320	173	230
400	398	210	500	405	195	260

**Weights**

Dimension	125	160	200	250	315	400
Weight [kg]	0,27	0,42	0,74	0,97	1,34	2,17

**Technical data**

**Symbols and specifications**

**Q** - air volume [ $m^3/h$ ]

**Lth** - length of the horizontal air flow for an end velocity of 0.2 m/s [ $m$ ]

**Aeff** - effective area of the nozzle [ $m^2$ ]

**Veff** - air velocity in the effective cross section [ $m/s$ ]

**Ps** - pressure loss of the nozzle [ $Pa$ ]

**Lw** - acoustic power level of the nozzle [ $dB(A)$ ]

## Parameter Selection Table for Isothermal Air Flow

Q [m <sup>3</sup> /h]	Ø	125	160	200	250	315	400
		Aeff [m <sup>2</sup> ] 0,0028	0,005	0,0087	0,0129	0,0214	0,0346
60	veff [m/s]	6	3,3				
	Lth [m]	15	9				
	Ps [Pa]	18	6				
	Lw [dB(A)]	<25	<25				
100	veff [m/s]	9,9	5,6	3,2			
	Lth [m]	39	14	12,40			
	Ps [Pa]	45	18	8			
	Lw [dB(A)]	<25	<25	<25			
200	veff [m/s]		11,1	6,4	4,3		
	Lth [m]		28	24,50	19,40		
	Ps [Pa]		75	33	13		
	Lw [dB(A)]		26	<25	<25		
300	veff [m/s]			9,6	6,5	3,9	
	Lth [m]			37	29	22,60	
	Ps [Pa]			73	21	11	
	Lw [dB(A)]			26	<25	<25	
400	veff [m/s]			12,8	8,6	5,2	
	Lth [m]			49	38	30	
	Ps [Pa]			130	52	19	
	Lw [dB(A)]			34	<25	<25	
600	veff [m/s]				12,9	7,8	4,8
	Lth [m]				58	45	33
	Ps [Pa]				118	43	12
	Lw [dB(A)]				33	<25	<25
800	veff [m/s]				17,2	10,4	6,4
	Lth [m]				77	60	43
	Ps [Pa]				210	77	21
	Lw [dB(A)]				41	31	<25
1000	veff [m/s]					13	8
	Lth [m]					75	54
	Ps [Pa]					120	33
	Lw [dB(A)]					38	27
1250	veff [m/s]					16,2	10
	Lth [m]					94	68
	Ps [Pa]					188	52
	Lw [dB(A)]					44	33
1500	veff [m/s]						12
	Lth [m]						82
	Ps [Pa]						75
	Lw [dB(A)]						38
2000	veff [m/s]						16,1
	Lth [m]						>100
	Ps [Pa]						133
	Lw [dB(A)]						46

Diagrams of Outlet Air Flow Directions

Cooling mode

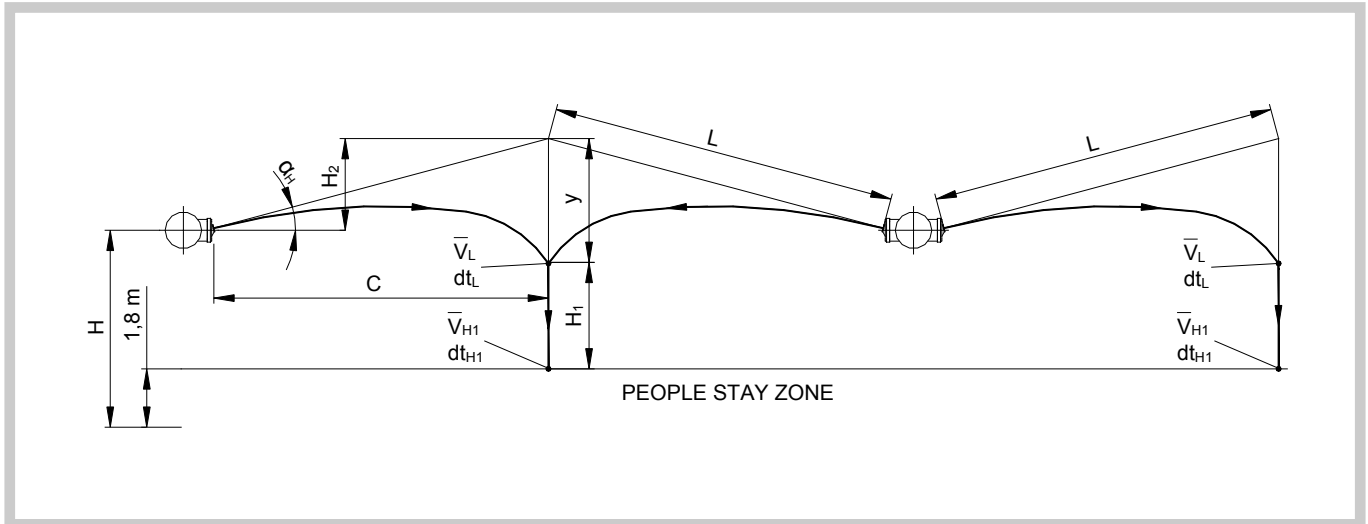

Isothermal air flow

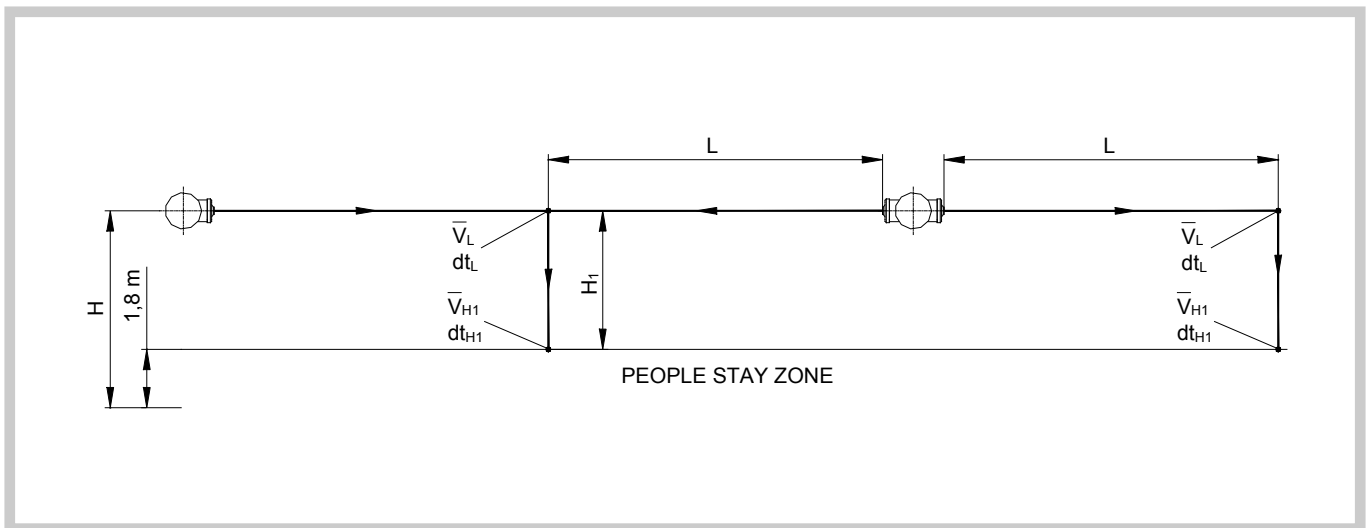

Heating mode

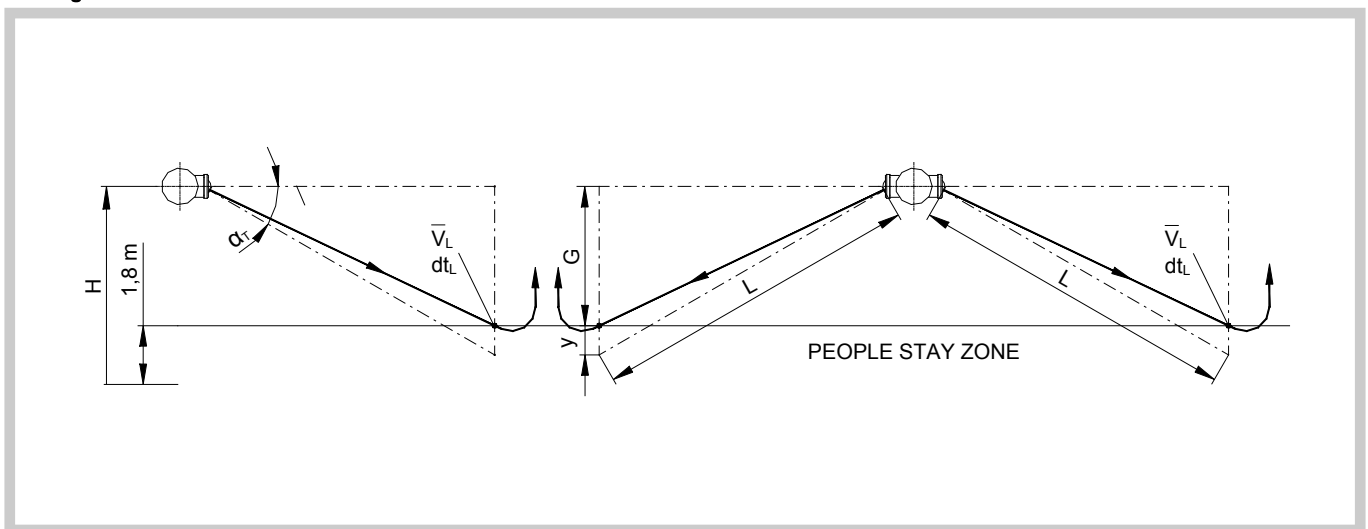

**Velocity in the core of the air flow and length of the flow**

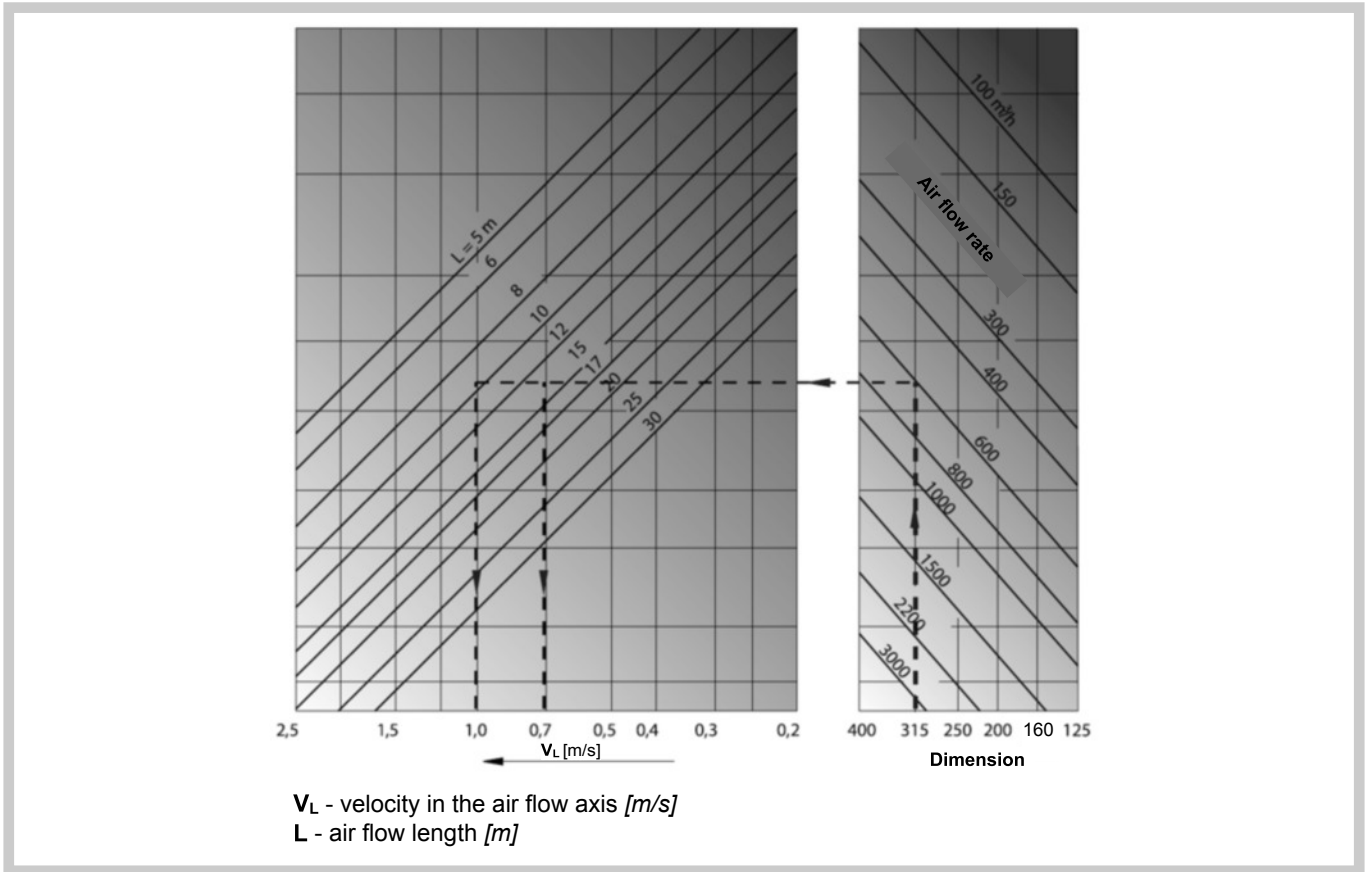

**Air flow bend**

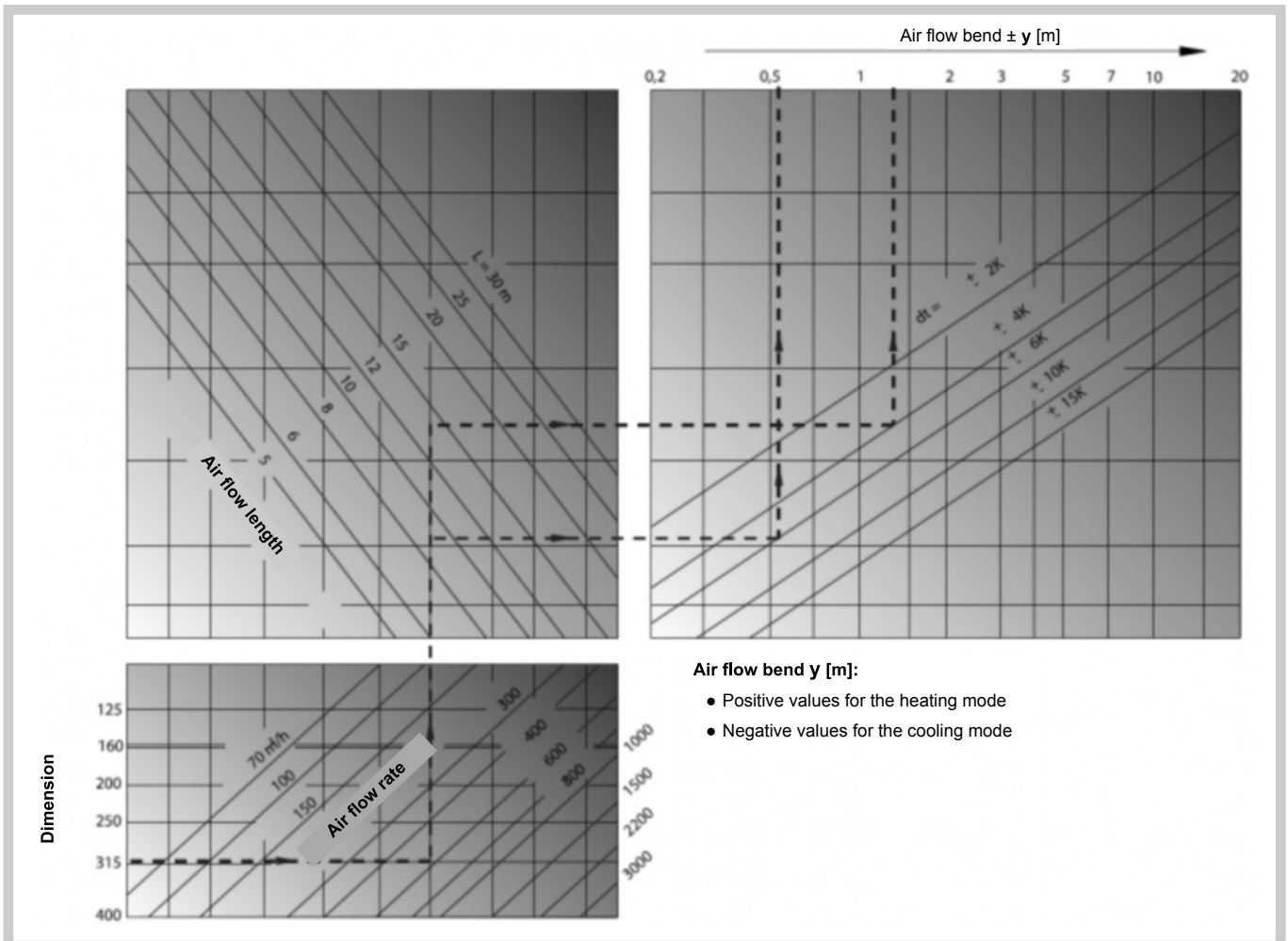

**Velocity in the air flow axis on the boundary of the people stay zone**

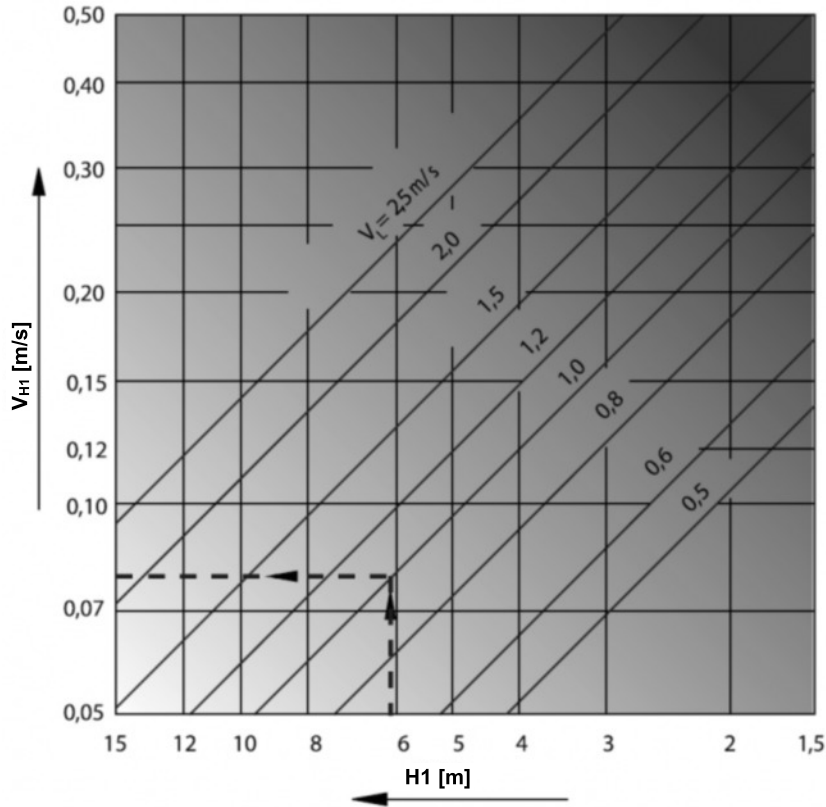

$V_{H1}$  - velocity in the air flow axis on the boundary of the people stay zone [m/s]  
 $H1$  - height of the beginning of the vertical air flow from the boundary of the people stay zone [m]

**Coefficient of Temperature**

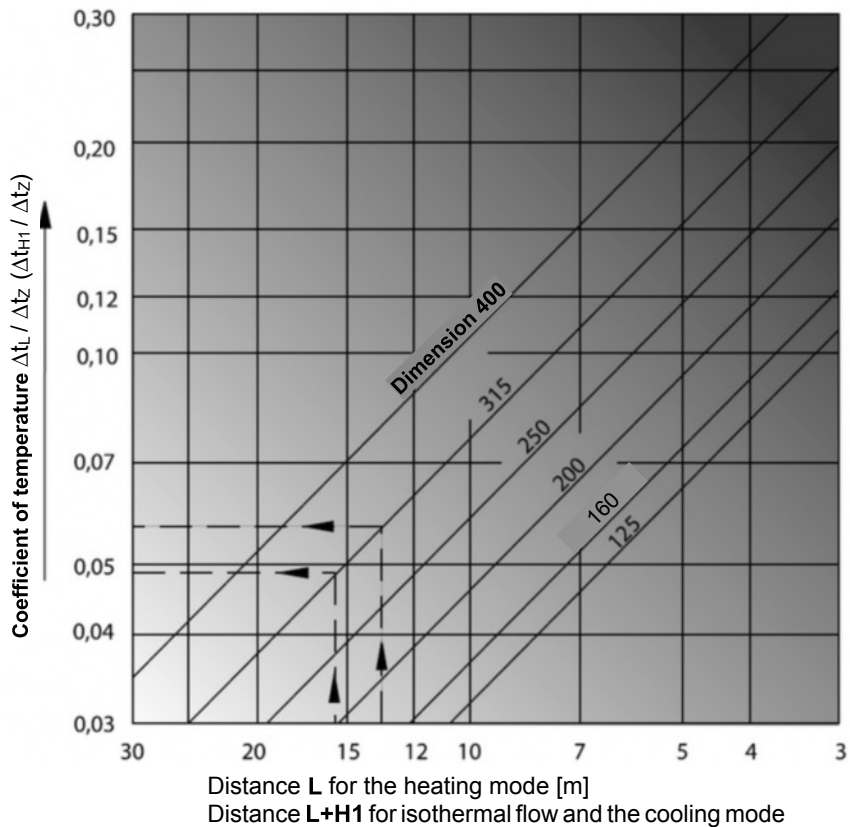

$\Delta t_L$  ... temperature difference between the air flow temperature and the room temperature (K)  
 $\Delta t_z$  ... temperature difference between the supply air temperature and the room air temperature (K)  
 $\Delta t_{H1}$  ... temperature difference between the air flow temperature on the boundary of the people stay zone and the room temperature (K)



**Pressure Losses and Acoustic Power Level**

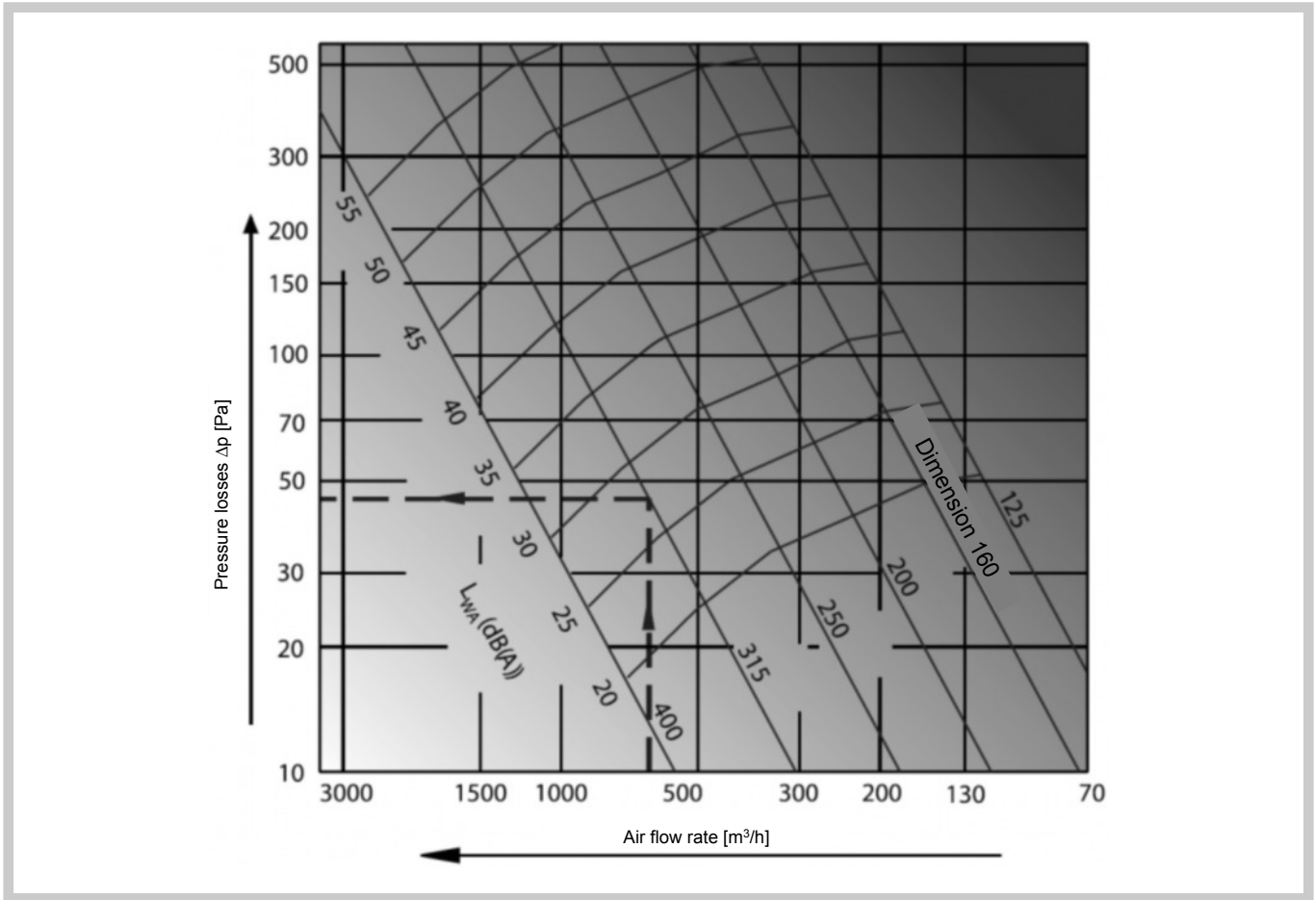

**Logistics terms**

The nozzles are packed in cardboard packaging. They are transported loose in covered vehicles. When handling during transport and storage, the nozzles must be protected against mechanical damage. The nozzles must be stored in covered buildings, in environments free of aggressive vapours, gases, and dust. The temperature in the buildings must be kept between -5 and +40 °C, with a maximum relative humidity of 80%.

MANDÍK, a.s.  
Dobříšská 550  
26724 Hostomice  
Czech Republic  
Tel.: +420 311 706 706  
E-Mail: [mandik@mandik.cz](mailto:mandik@mandik.cz)  
[www.mandik.com](http://www.mandik.com)

---

The producer reserves the right for innovations of the product. For actual product information see  
[www.mandik.com](http://www.mandik.com)